

SEMiX303GB12E4s



SEMiX[®] 3s

Trench IGBT Modules

SEMiX303GB12E4s

Features

- Homogeneous Si
- Trench = Trenchgate technology
- $V_{CE(sat)}$ with positive temperature coefficient
- High short circuit capability
- UL recognized, file no. E63532

Typical Applications*

- AC inverter drives
- UPS
- Electronic Welding

Remarks

- Case temperature limited to $T_C=125^\circ\text{C}$ max.
- Product reliability results are valid for $T_j=150^\circ\text{C}$
- Dynamic values apply to the following combination of resistors:
 $R_{Gon,main} = 1,0 \Omega$
 $R_{Goff,main} = 1,0 \Omega$
 $R_{G,X} = 2,0 \Omega$
 $R_{E,X} = 0,5 \Omega$

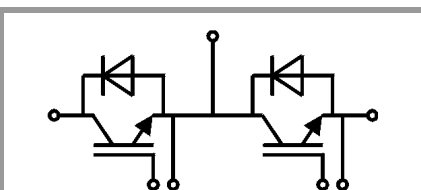

GB

Absolute Maximum Ratings				
Symbol	Conditions	Values	Unit	
IGBT				
V_{CES}	$T_j = 25^\circ\text{C}$	1200	V	
I_C	$T_j = 175^\circ\text{C}$	$T_c = 25^\circ\text{C}$	466	A
		$T_c = 80^\circ\text{C}$	359	A
I_{Cnom}		300	A	
I_{CRM}	$I_{CRM} = 3 \times I_{Cnom}$	900	A	
V_{GES}		-20 ... 20	V	
t_{psc}	$V_{CC} = 800\text{ V}$ $V_{GE} \leq 20\text{ V}$ $V_{CES} \leq 1200\text{ V}$	$T_j = 150^\circ\text{C}$	10	μs
T_j		-40 ... 175	$^\circ\text{C}$	
Inverse diode				
I_F	$T_j = 175^\circ\text{C}$	$T_c = 25^\circ\text{C}$	338	A
		$T_c = 80^\circ\text{C}$	252	A
I_{Fnom}		300	A	
I_{FRM}	$I_{FRM} = 3 \times I_{Fnom}$	900	A	
I_{FSM}	$t_p = 10\text{ ms, sin } 180^\circ, T_j = 25^\circ\text{C}$	1485	A	
T_j		-40 ... 175	$^\circ\text{C}$	
Module				
$I_{t(RMS)}$	$T_{terminal} = 80^\circ\text{C}$	600	A	
T_{stg}		-40 ... 125	$^\circ\text{C}$	
V_{isol}	AC sinus 50Hz, t = 1 min	4000	V	

Characteristics					
Symbol	Conditions	min.	typ.	max.	Unit
IGBT					
$V_{CE(sat)}$	$I_C = 300\text{ A}$ $V_{GE} = 15\text{ V}$ chipelevel	$T_j = 25^\circ\text{C}$	1.8	2.05	V
		$T_j = 150^\circ\text{C}$	2.2	2.4	V
V_{CE0}	chipelevel	$T_j = 25^\circ\text{C}$	0.8	0.9	V
		$T_j = 150^\circ\text{C}$	0.7	0.8	V
r_{CE}	$V_{GE} = 15\text{ V}$ chipelevel	$T_j = 25^\circ\text{C}$	3.3	3.8	$\text{m}\Omega$
		$T_j = 150^\circ\text{C}$	5.0	5.3	$\text{m}\Omega$
$V_{GE(th)}$	$V_{GE}=V_{CE}, I_C = 11.4\text{ mA}$	5	5.8	6.5	V
I_{CES}	$V_{GE} = 0\text{ V}$ $V_{CE} = 1200\text{ V}$	$T_j = 25^\circ\text{C}$		4.0	mA
		$T_j = 150^\circ\text{C}$			mA
C_{ies}	$V_{CE} = 25\text{ V}$		18.5		nF
C_{oes}	$V_{GE} = 0\text{ V}$		1.22		nF
C_{res}			1.03		nF
Q_G	$V_{GE} = -8\text{ V...} + 15\text{ V}$		1695		nC
R_{Gint}	$T_j = 25^\circ\text{C}$		2.50		Ω
$t_{d(on)}$	$V_{CC} = 600\text{ V}$ $I_C = 300\text{ A}$	$T_j = 150^\circ\text{C}$	255		ns
t_r	$V_{GE} = \pm 15\text{ V}$	$T_j = 150^\circ\text{C}$	57		ns
E_{on}	$R_{Gon} = 1.9\ \Omega$	$T_j = 150^\circ\text{C}$	30		mJ
$t_{d(off)}$	$R_{Goff} = 1.9\ \Omega$	$T_j = 150^\circ\text{C}$	565		ns
t_f	$di/dt_{on} = 5250\text{ A}/\mu\text{s}$ $di/dt_{off} = 2825\text{ A}/\mu\text{s}$	$T_j = 150^\circ\text{C}$	98		ns
E_{off}		$T_j = 150^\circ\text{C}$	41.2		mJ
$R_{th(j-c)}$	per IGBT			0.095	K/W

SEMiX303GB12E4s



SEMiX® 3s

Trench IGBT Modules

SEMiX303GB12E4s

Features

- Homogeneous Si
- Trench = Trenchgate technology
- $V_{CE(sat)}$ with positive temperature coefficient
- High short circuit capability
- UL recognized, file no. E63532

Typical Applications*

- AC inverter drives
- UPS
- Electronic Welding

Remarks

- Case temperature limited to $T_C=125^\circ\text{C}$ max.
- Product reliability results are valid for $T_j=150^\circ\text{C}$
- Dynamic values apply to the following combination of resistors:
 $R_{Gon,main} = 1,0 \Omega$
 $R_{Goff,main} = 1,0 \Omega$
 $R_{G,X} = 2,0 \Omega$
 $R_{E,X} = 0,5 \Omega$

Characteristics						
Symbol	Conditions		min.	typ.	max.	Unit
Inverse diode						
$V_F = V_{EC}$	$I_F = 300 \text{ A}$ $V_{GE} = 0 \text{ V}$ chipelevel	$T_j = 25^\circ\text{C}$		2.2	2.52	V
		$T_j = 150^\circ\text{C}$		2.2	2.5	V
V_{F0}	chipelevel	$T_j = 25^\circ\text{C}$	1.1	1.3	1.5	V
		$T_j = 150^\circ\text{C}$	0.7	0.9	1.1	V
r_F	chipelevel	$T_j = 25^\circ\text{C}$	2.7	3.0	3.4	m Ω
		$T_j = 150^\circ\text{C}$	3.5	4.2	4.6	m Ω
I_{RRM}	$I_F = 300 \text{ A}$	$T_j = 150^\circ\text{C}$		300		A
Q_{rr}	$di/dt_{off} = 5100 \text{ A}/\mu\text{s}$	$T_j = 150^\circ\text{C}$		44.2		μC
E_{rr}	$V_{GE} = -15 \text{ V}$ $V_{CC} = 600 \text{ V}$	$T_j = 150^\circ\text{C}$		17.7		mJ
$R_{th(j-c)}$	per diode				0.18	K/W
Module						
L_{CE}				20		nH
$R_{CC'+EE'}$	res., terminal-chip	$T_C = 25^\circ\text{C}$		0.7		m Ω
		$T_C = 125^\circ\text{C}$		1		m Ω
$R_{th(c-s)}$	per module			0.04		K/W
M_s	to heat sink (M5)		3		5	Nm
M_t		to terminals (M6)	2.5		5	Nm
						Nm
w					300	g
Temperature Sensor						
R_{100}	$T_C=100^\circ\text{C}$ ($R_{25}=5 \text{ k}\Omega$)			$493 \pm 5\%$		Ω
$B_{100/125}$	$R(T)=R_{100}\exp[B_{100/125}(1/T-1/T_{100})]$; $T[\text{K}]$;			$3550 \pm 2\%$		K



GB

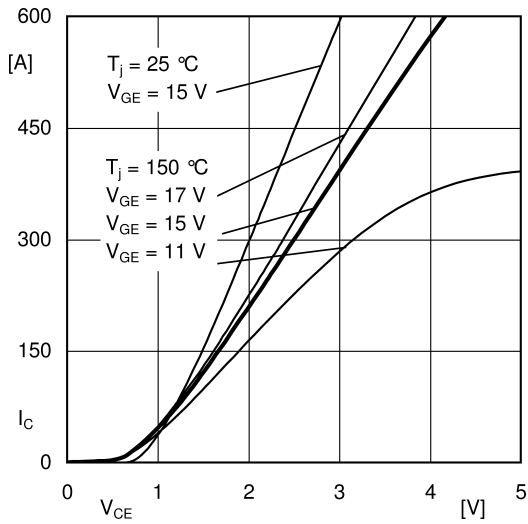

Fig. 1: Typ. output characteristic, inclusive $R_{CC'+EE'}$

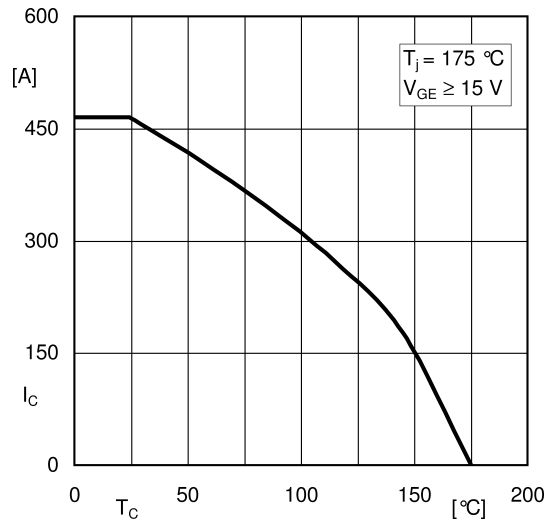

Fig. 2: Rated current vs. temperature $I_C = f(T_C)$

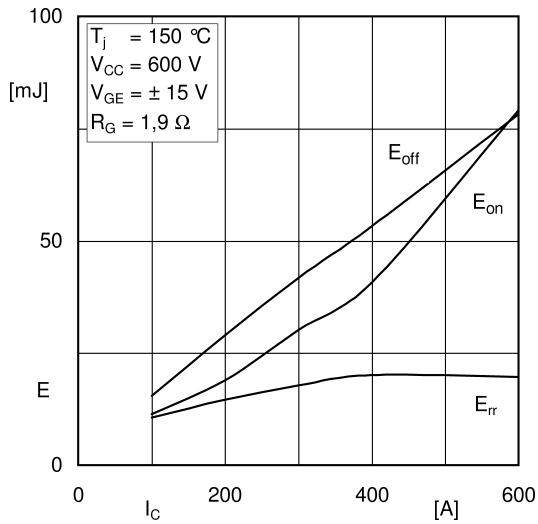

Fig. 3: Typ. turn-on /-off energy = $f(I_C)$

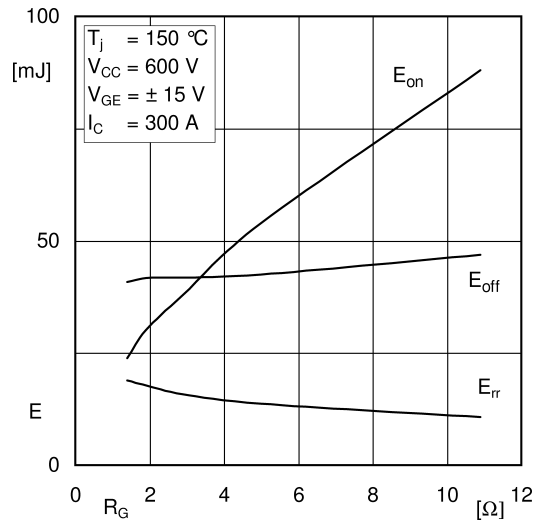

Fig. 4: Typ. turn-on /-off energy = $f(R_G)$

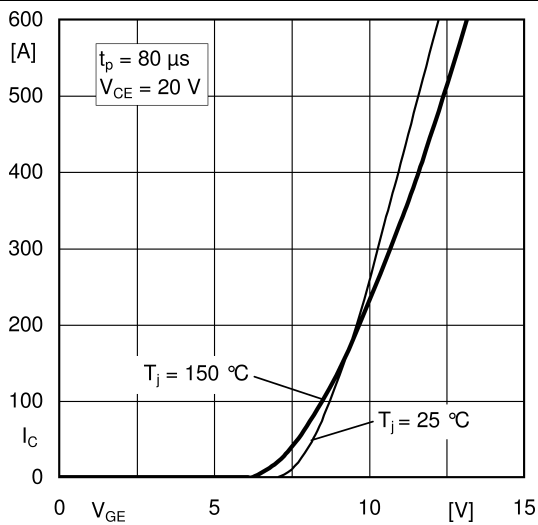

Fig. 5: Typ. transfer characteristic

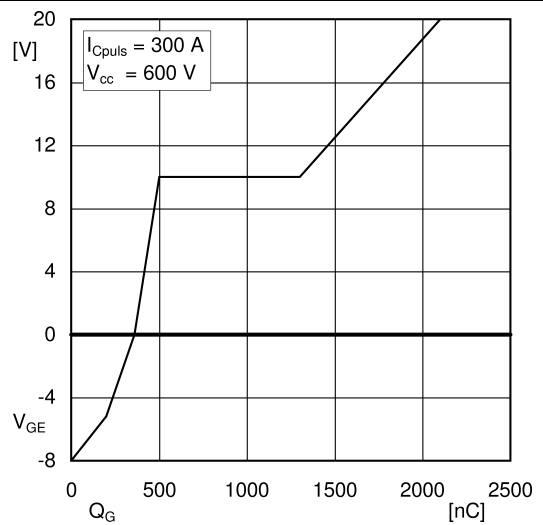

Fig. 6: Typ. gate charge characteristic

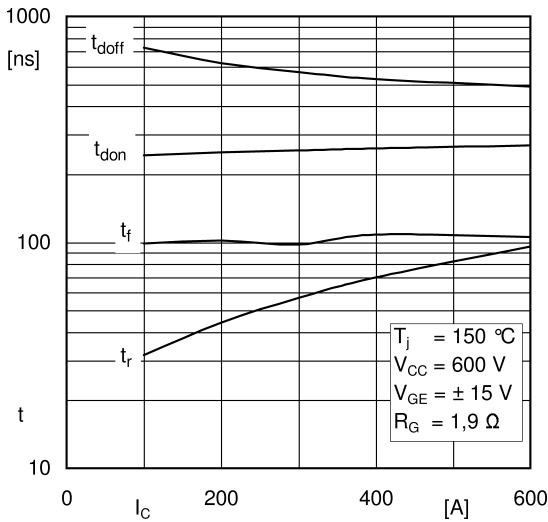

Fig. 7: Typ. switching times vs. I_C

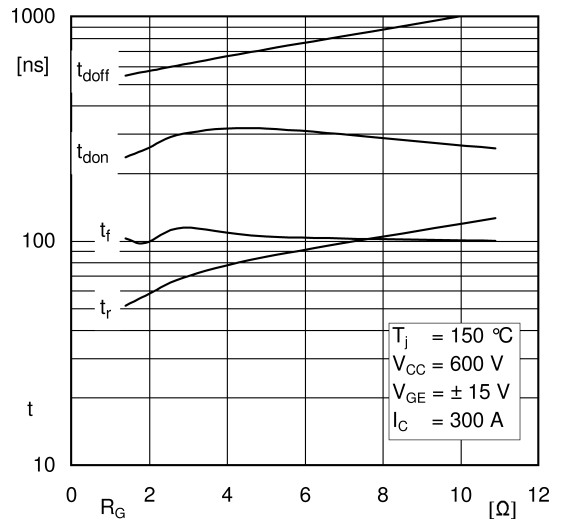

Fig. 8: Typ. switching times vs. gate resistor R_G

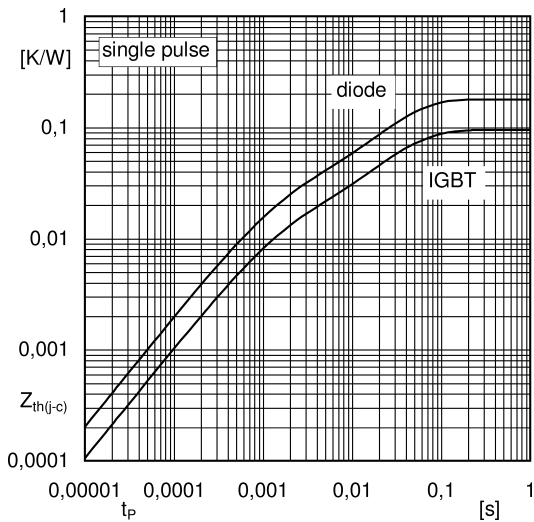

Fig. 9: Typ. transient thermal impedance

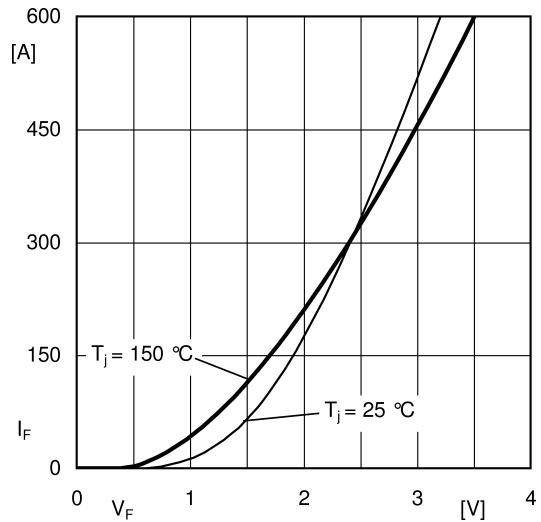

Fig. 10: Typ. CAL diode forward charact., incl. R_{CC+EE}

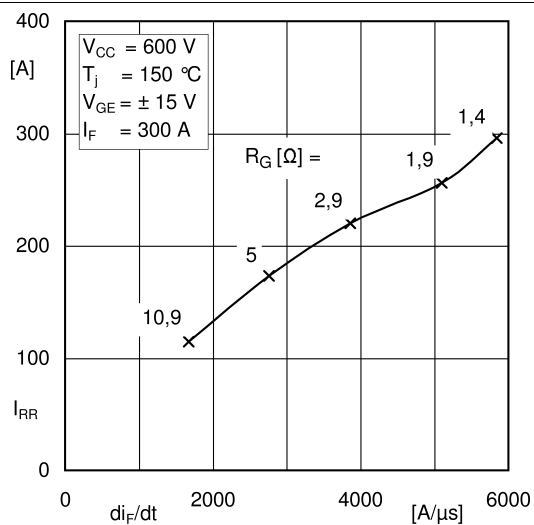

Fig. 11: Typ. CAL diode peak reverse recovery current

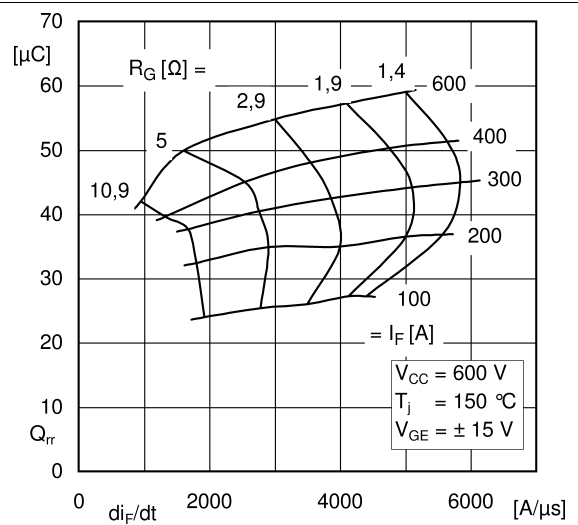
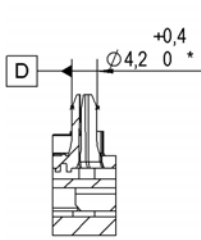

Fig. 12: Typ. CAL diode recovery charge

SEMiX303GB12E4s

Case: SEMiX 3s

guide pin left
F-F (1 : 1)



screw duct
(1x centre):
H-H (1 : 1)

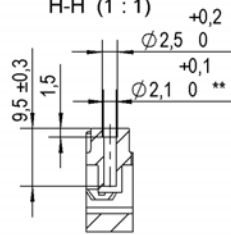

	0,3	connector 1-2 / 3-4
	0,2	each connector

general tolerance:
ISO 2768-m
ISO 8015

screw duct (6x)
spring duct (16x):
G-G (1 : 1)

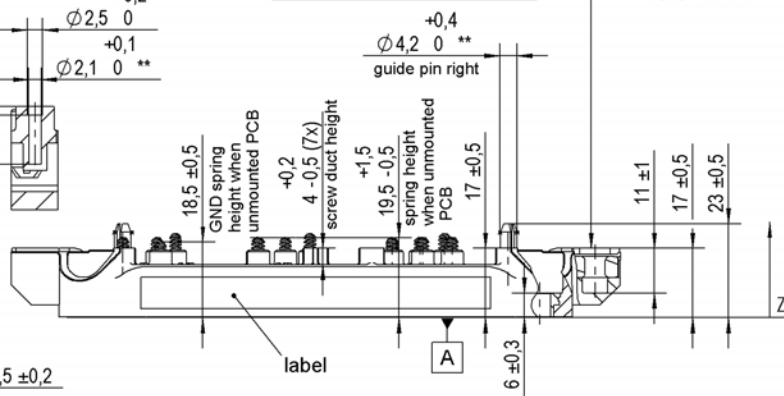
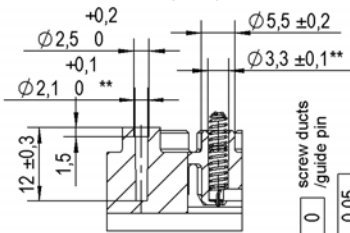

All measures in Z-direction
valid when mounted to heat sink

marking of
terminals

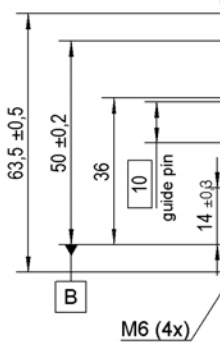

screw duct
top view(7x):
J (2 : 1)

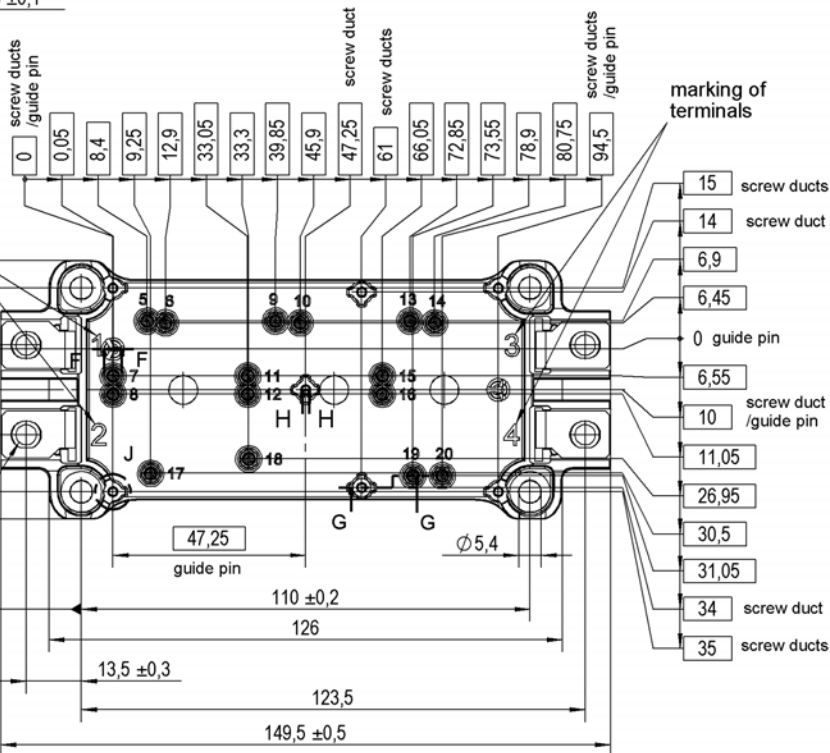
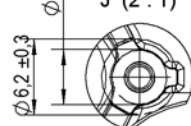

*guide pin left with

	0,25	A	B	C
--	------	---	---	---

**screw ducts / spring ducts / guide pin right with

	0,5	A	B	D
--	-----	---	---	---

Rules for the contact PCB:

- holes guidepins = $\varnothing 4 \pm 0,1$ / position tolerance $\pm 0,1$
- holes for screws = $\varnothing 3,3 \pm 0,1$ / position tolerance $\pm 0,1$
- spring contact pad = $\varnothing 3,6 \pm 0,1$ / position tolerance $\pm 0,1$

SEMiX 3s

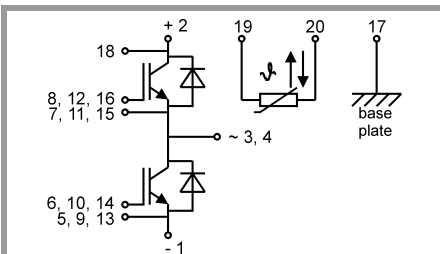

spring configuration

This is an electrostatic discharge sensitive device (ESDS), international standard IEC 60747-1, Chapter IX

* The specifications of our components may not be considered as an assurance of component characteristics. Components have to be tested for the respective application. Adjustments may be necessary. The use of SEMIKRON products in life support appliances and systems is subject to prior specification and written approval by SEMIKRON. We therefore strongly recommend prior consultation of our staff.